



ULTRAVIOLET DISINFECTION
EQUIPMENT FOR THE TREATMENT OF DRINKING WATER

SMP 7 ECO 230



MANUAL OF INSTALLATION, USE AND SERVICING

English 04-2023 Rev.G



INDEX

1. Introduction.....	3
2. General Principles.....	4
3. Installation Guidance	6
3.1. Mechanical Connection	7
3.2. Electrical Connection.....	10
4. Safety measures and regulations.....	13
4.1. Electricity.....	13
4.2. Mechanical dangers	13
4.3. Exposure to high intensity UV light	13
5. Run the System	14
6. Display Information (Troubleshooting).....	15
7. Electrical Panel Description.....	21
7.1 External View	21
7.2 Internal View and Electrical Components	22
7.3 Mains Power Connections/ Input-Output Terminals	22
8. Reactor Dimensions	23
a. SMP 7 ECO	23
9. Technical Data Sheet	23
a. SMP 7 ECO	23
10. Maintenance.....	24
11. Spare Part Lists	28
13. Electrical Panel Spare Parts	30
14. Electrical Diagram	30
15. Warranty Conditions.....	31
16. Declaration Of Conformity.....	32

1. Introduction

This manual is for the following models:

SMP 7 ECO 230

This Pressure UV Systems is manufactured by **S.I.T.A. s.r.l.**

Warning: This equipment requires regular maintenance to ensure the requirements of the drinking water treated and the maintenance of the improvements as stated by the manufacturer.

These operating instructions contain important information for the operation and maintenance of the equipment.

Please ensure that these operating instructions are carefully read by all relevant persons before putting the unit into operation, this ensures the safe use of the UV system. The operating instructions are an integral part of the equipment supply.

Before putting the unit into operation, all conditions necessary for the safe operation of the equipment must be fulfilled.

The installation, commissioning and maintenance of the equipment should only be carried out by qualified personnel.

The equipment should only be operated by authorized personnel who have been trained accordingly.

No modifications should be made to the equipment without consulting S.I.T.A., as this could effect the safe operation of the unit. S.I.T.A. shall not be held responsible for damage resulting from unapproved modifications.



INSTRUCTION:

The operating instructions are to be kept where they will be accessible for operating and maintenance personnel.

2. General Principles

Information about UV irradiation

The use of UV RADIATION is now recognised as one of the finest technologies for disinfecting water. The UV rays are reproduced using special very pure quartz lamps containing mercury vapour that, when suitably activated by means of a current passing between electrodes, emits photons with varying amounts of energy in the deactivation phase, which results in the characteristic UV spectrum.

The inactivity of the pathogen microorganisms is due to the damage caused to the molecules of the nucleic acids by this radiation, which results in their cellular replication being compromised.

The fact that the water's chemical/physical and organoleptic qualities are not altered, and the complete absence of sub-products of disinfection, means that it is currently one of the safest and most commonly used technologies for disinfecting water.

Depending on their operating conditions, MERCURY VAPOUR LAMPS are able to emit radiation at differing wavelengths. Where the gases they contain are at low pressure and temperature, they produce the characteristic monochromatic spectrum (UV-C, $\lambda = 253,7$ nm). Higher pressures and temperatures make it possible for other wavelengths to be produced that provide the polychromatic spectrum that is typical of MEDIUM PRESSURE lamps (UV-A, UV-B, UV-C).

In addition to the effective germicide action of the UV-C rays, the other UV components emitted cause the photochemical degradation of some substances such as chloramines.

SITA has made use of these favourable characteristics and has added MEDIUM PRESSURE lamps to their UV-C de-bacterial UV plants (that use low pressure lamps), in order to take advantage of all the potential of ultraviolet light.

Due to the higher output from the lamps, SITA's MEDIUM PRESSURE UNITS are able to treat large water flow-rates, while remaining compact in size. When suitably sized for its germicidal action, UV-C also provides a photochemical degradation effect.

General Directions

According to the European rules EN 60204-1 (safety of the set-up off the electrical equipment-general rules) the low tension electrical instruments (rule 2014/35/CE) must be connected to a current-tap provided with grounding.

Safety directions



The light of ultra-violet lamps can cause serious burns to unprotected skin and eyes, therefore it is strictly recommended not to connect it to the current tap without having before ensured the UV lamp in its housing and inserted the PVC cover.

Run-down lamps with mercury vapors should be considered special refuse.

For this reason you **must** get rid of them according the law.

Indications for the disposal

We remind that, according to D.L. 4 May 2014, N°27 "Accomplishment of directive 2011/65/CE, concerning the reduction of dangerous substances in electric and electronic equipments" both mercury vapours lamps and electrical panels, when no more used, must be considered as special waste, and in the same way disposed of.

To do that, it is possible to address to specialized centres for the recovery of dangerous materials, or to contact directly our technical department.



INFORMATION TO USERS pursuant to art. 14 of the 2012/19 / EU DIRECTIVE OF THE EUROPEAN PARLIAMENT AND OF THE COUNCIL of 4 July 2012 on waste electrical and electronic equipment (WEEE)

 The crossed bin symbol on the appliance or on its packaging indicates that the product at the end of its useful life must be collected separately and not disposed of together with other mixed urban waste.

Please contact your municipality, or local authority, for all information regarding the separate collection systems available in the area. The retailer is obliged to collect the old equipment free of charge when buying new equipment of an equivalent type, for the purpose of starting the correct recycling / disposal.

Appropriate separate collection for the subsequent start-up of the disused equipment for recycling, treatment and environmentally compatible disposal helps to avoid possible negative effects on the environment and on health and favors the re-use and / or recycling of the materials it is composed of the equipment

Electricity:



The lightning flash and arrowhead symbol is to alert the user to the presence of un-insulated "DANGEROUS VOLTAGE" within the enclosure.

The equipment may only be opened if the mains supply is isolated. The mains supply must not be restored as long as the equipment is open. This applies to both the electrical control panel and the reactor vessel.



Attention:

Working on live equipment is forbidden.



Attention:

The light of ultra-violet lamps can cause serious burns to unprotected skin and eyes.

3. Installation Guidance

Each UV Systems is made of an electrical panel and a stainless steel collector. The reactor control panel uses air cooling. The following guidelines must be followed.

IMPORTANT:

- ✓ The reactor and control panel must not be located in a position where the ambient air temperature exceeds 45°C.
- ✓ The reactor and control panel must not be located adjacent to other equipment that directly emit heat.
- ✓ The reactor and control panel must not be located adjacent to any chemical equipment that is likely to emit fumes (eg. Chlorine).
- ✓ If the system is installed after the filters, it is recommended that a fine mesh strainer basket should be incorporated downstream of the reactor to protect against glass particles entering the pool in the unlikely event of the reactor internal glass quartz breaking in operation or during routine maintenance.
- ✓ It is recommended that the main piping incorporates a valved bypass around the reactor as well as isolating valves for the inlet and outlet connections thereby allowing the pool flow to be bypassed around the reactor during maintenance.
- ✓ Chemical dosing connections should, where possible, be incorporated downstream of the reactor.

Failure to comply with any of the above criteria could affect the operation and warranty of the unit and have an adverse effect on the long term reliability and lifespan of the system.

3.1. Mechanical Connection

1. Install the reactor as suggested in the following technical drawing.

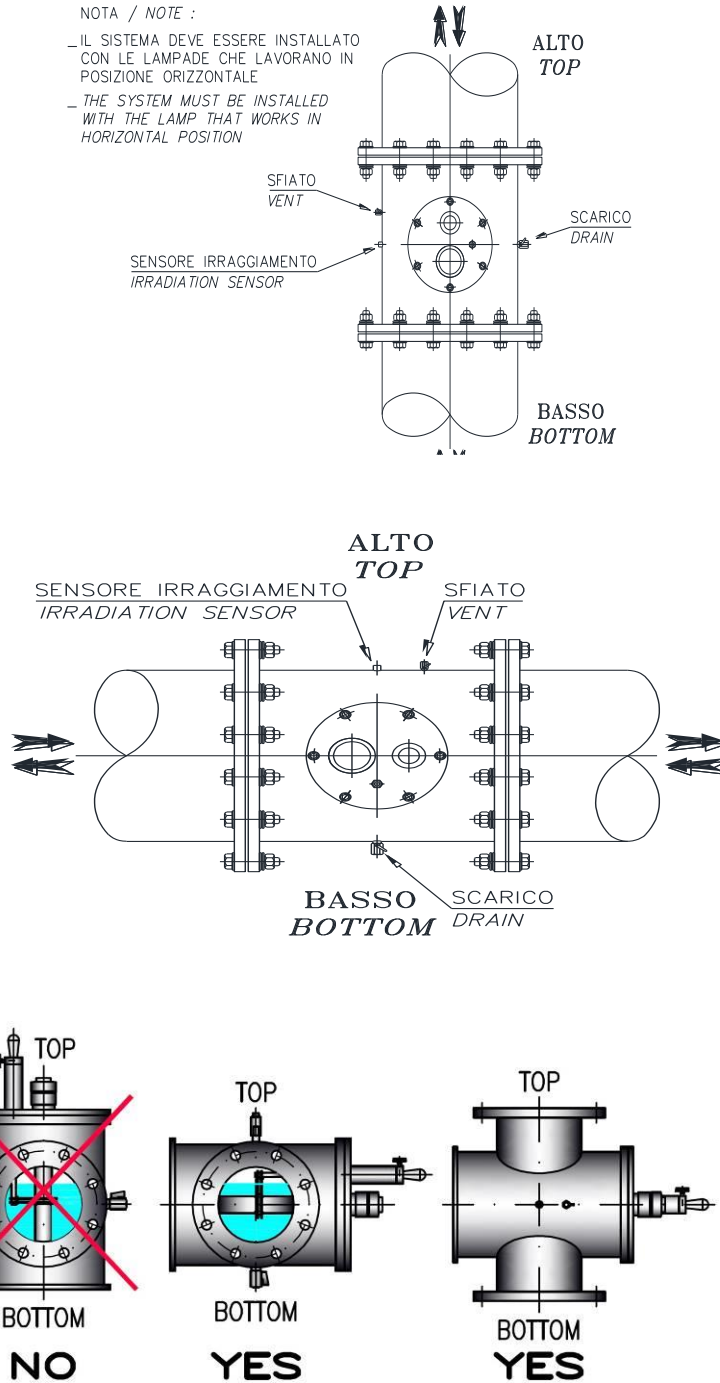

2. It is recommended that the main piping incorporates a valved bypass around the reactor as well as isolating valves for the inlet and outlet connections thereby allowing the flow to be bypassed around the reactor during maintenance.



IMPORTANT:

Do not install plastic valves directly connected to the UV system.
UV radiation may ruin the plastic of valves sealing.

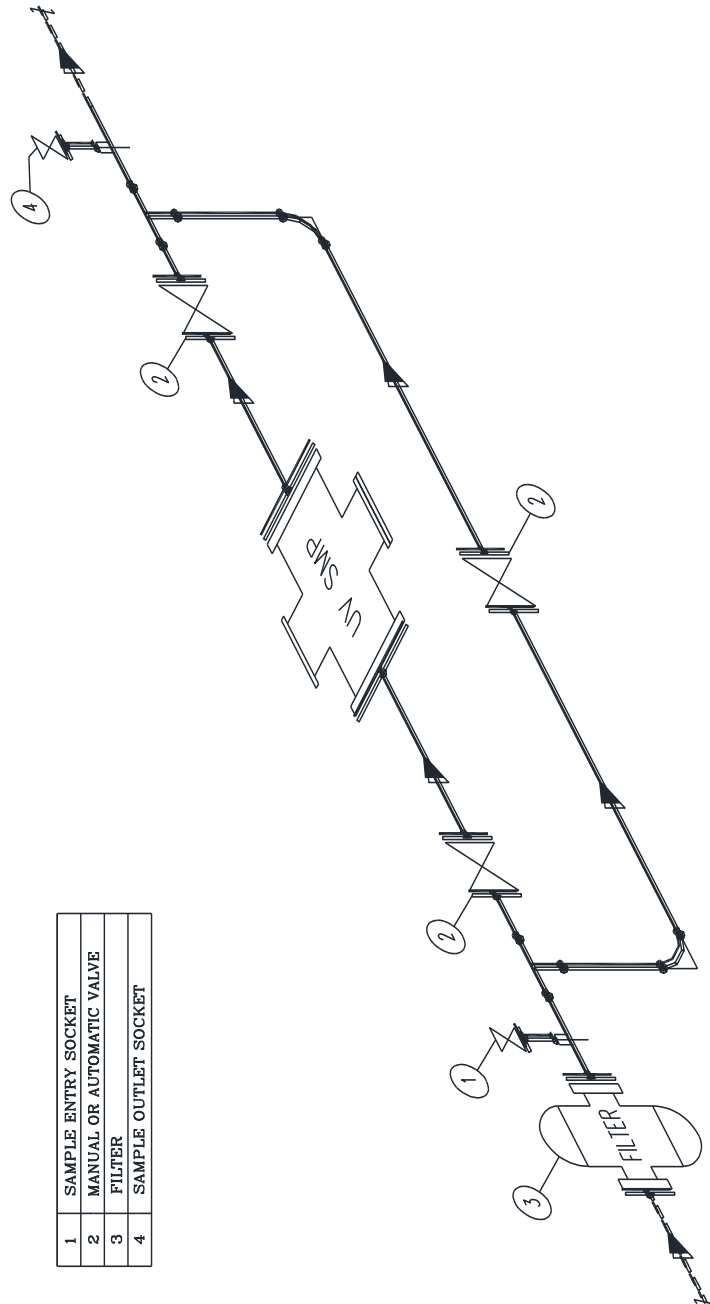

3. Insert sensor (with o-ring) into the chamber port.



4. Install drain and vent valves.

5. Open the vent valve and close the by-pass.

6. Vent the air out of the reactor.

7. Let the water pass through the SMP and check if there are signs of leaking inside the quartz sleeve.

3.2. Electrical Connection

The electrical installation must only be carried out by a qualified electrical engineer. The electrical supply to the unit must be earthed.

1. Feed the electrical panel as in the following technical drawing.

SMP ECO

NOTE: SMP ELECTRICAL PANEL MUST BE SUPPLIED FOLLOWING THIS DRAWING.
IN THIS WAY TURNING OFF THE PUMP, SMP WILL TURN OFF.

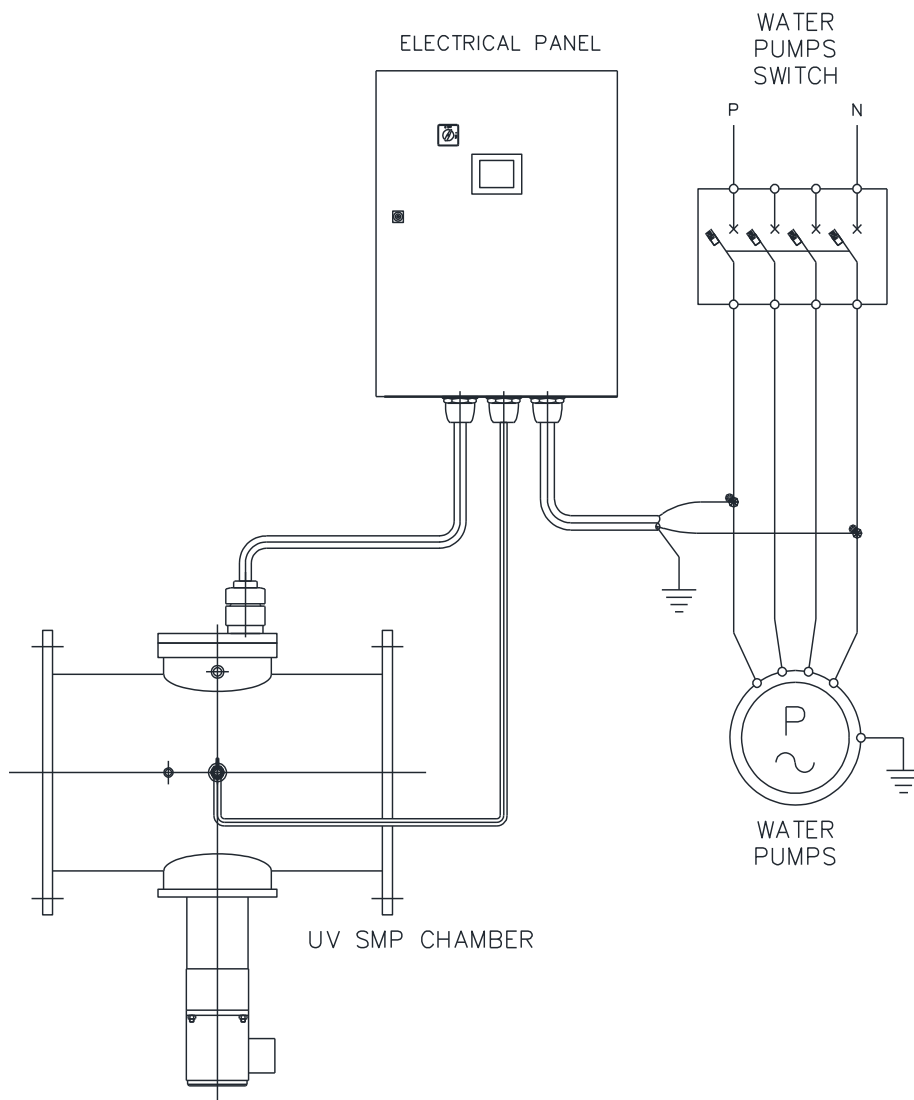

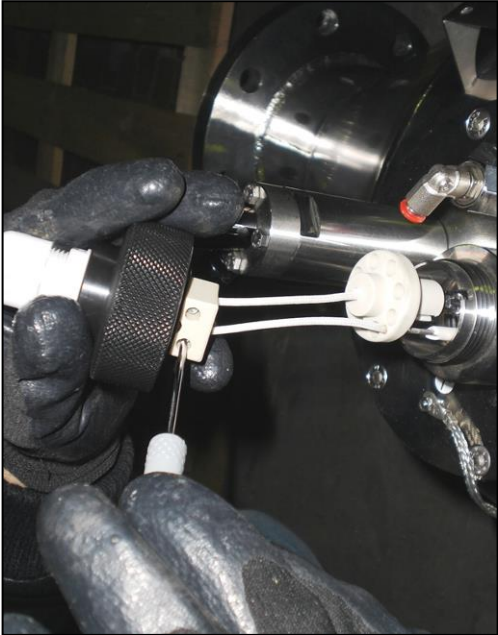

2 Connect the lamp's terminals.

3 Insert the lamp into the quartz already present in the stainless steel chamber.

4 Make the grounding of the stainless steel chamber.

5 Lamp return wire has to be placed bottom side (between 3:00 and 9:00 o'clock)

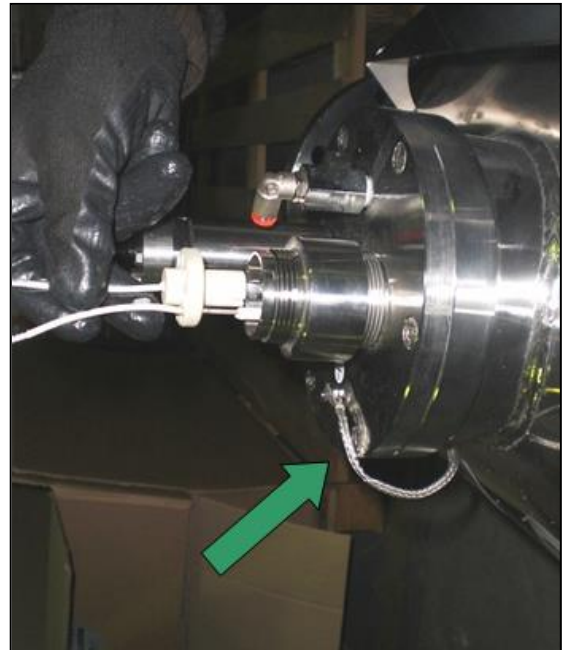
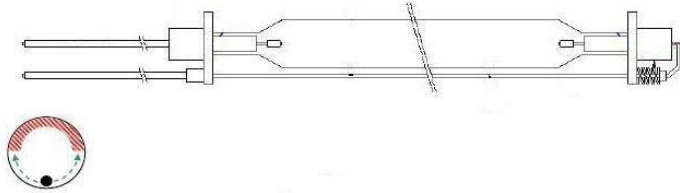

6 Screw the ring nuts on the sleeve bolts.



7 Connect UV sensor cable

8 Connect the power supply:
Check that the main electrical power supply is isolated to the control panel. (About the wiring see section Electrical Panel Description).

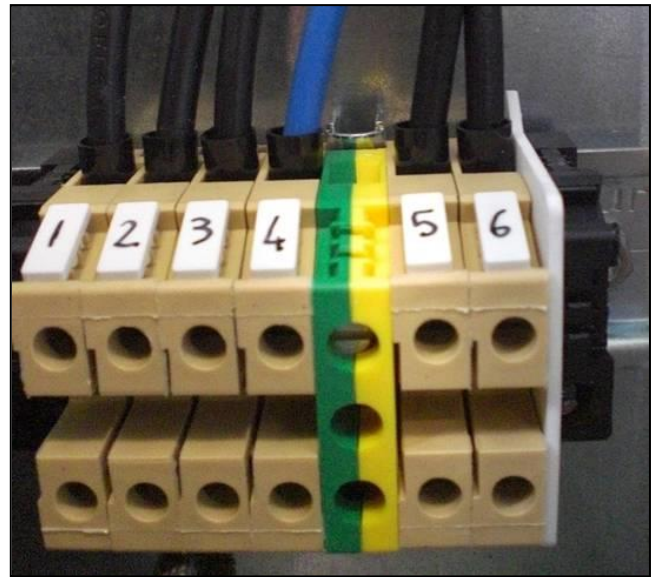

9 Turn the UV system on with the general switch (the lamp will light after few minutes). Do not open the electrical board without turning out the general switch. We remind you to test the differential switch every month. Lamp lights on only after some minutes to allow cooling after ON/OFF/ON cycle.

10 After 30 working minutes calibrate the sensor (see section “UV Controller”)

4. Safety measures and regulations

The equipment must be installed, put into operation and maintained by trained specialists. The owner and/or user must ensure that the operating personnel has been suitably instructed.

The equipment has been subjected to a hazard analysis, corresponding precautionary measures regarding the safety of persons and domestic animals have been made. Nevertheless, it is still possible that **danger could arise** as a result of incorrect use, bad maintenance, material changes, etc. These dangers are associated with:

- ✓ Electricity
- ✓ Mechanical dangers
- ✓ Exposure to high intensity UV light

4.1. Electricity

The lightning flash and arrowhead symbol is to alert the user to the presence of un-insulated **"DANGEROUS VOLTAGE"** within the enclosure.

The equipment may **only** be opened if the mains supply is isolated. The mains supply must **not** be restored as long as the equipment is open.



ATTENTION:
Working on live equipment is forbidden.

4.2. Mechanical dangers

The equipment contains glass which must be handled with care. Broken lamps emit dangerous mercury vapours.

4.3. Exposure to high intensity UV light

The reactor contains UV emitting lamps and if exposed while energized can cause serious eye and skin damage. Ensure that the mains supply is isolated before opening any of the covers of the reactor.

5. Run the System

The commissioning personnel authorised by the owner and/or user, must read and understand the operating instructions.

The commissioning personnel must be familiar with the safety measures and regulations applicable to the country/area in which the system is installed.

Turn On/Off the system

The preconditions for starting are:

- ✓ Water is flowing through the vessel.
- ✓ The electrical panel is powered
- ✓ The lamps have been turned off for 10 minutes

If all these conditions are respected turn on the general switch.



To shut OFF the system turn off the general switch.

6. Display Information (Troubleshooting)

LCD DISPLAY MESSAGES – Start up:

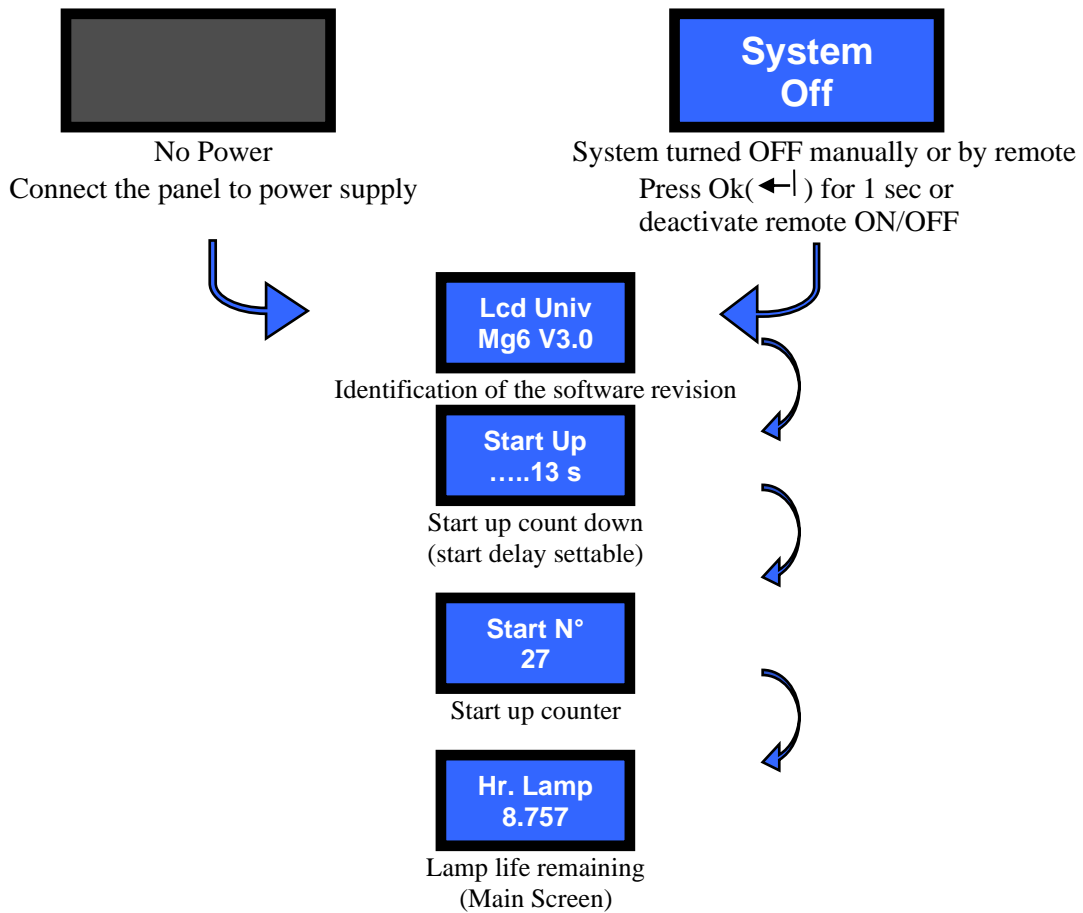

LCD DISPLAY MESSAGES – Shut Off:

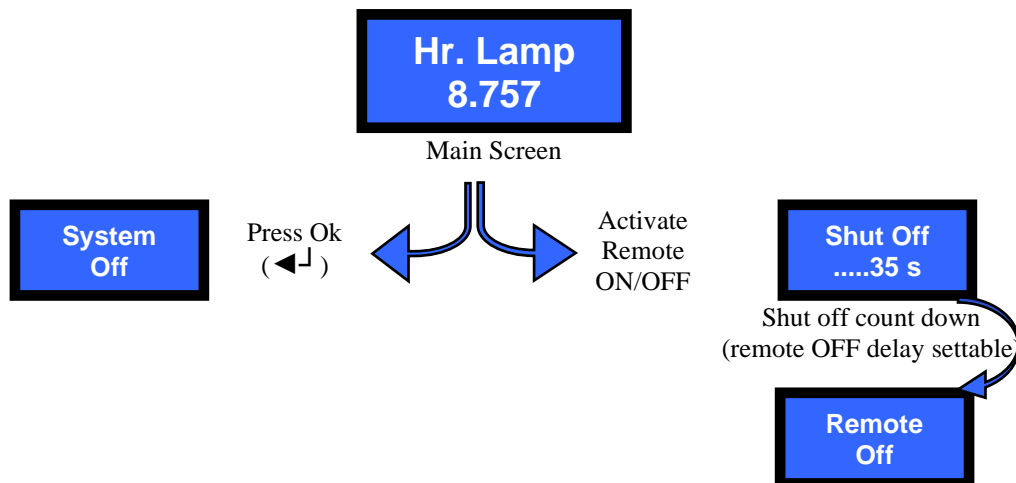

LCD DISPLAY MESSAGES – Main MENU:

The main MENU describes the main functions of the control Panel

To enter the main menus push one of the 3 buttons. Move through the menus using up and down arrow buttons.

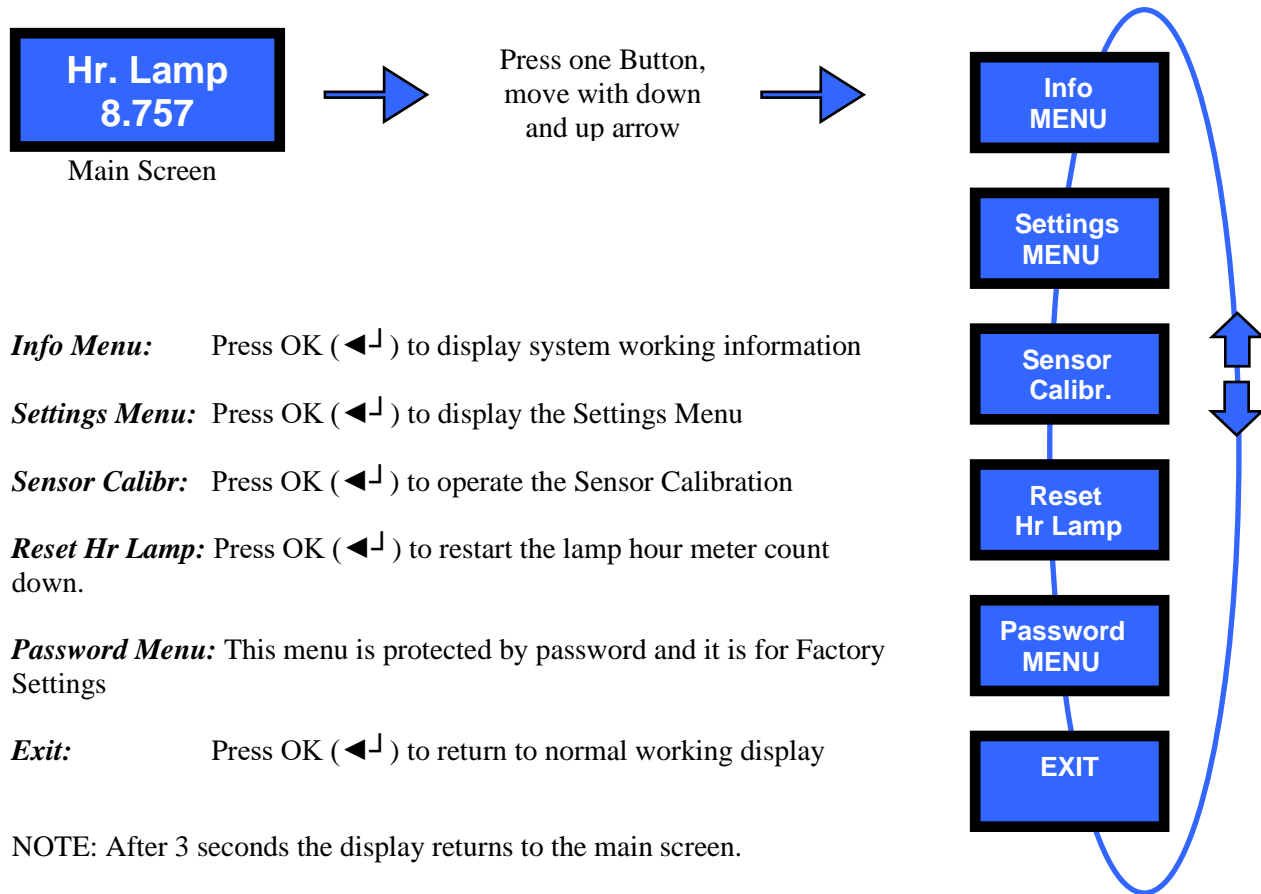

Info Menu: Press OK (◀↵) to display system working information

Settings Menu: Press OK (◀↵) to display the Settings Menu

Sensor Calibr: Press OK (◀↵) to operate the Sensor Calibration

Reset Hr Lamp: Press OK (◀↵) to restart the lamp hour meter count down.

Password Menu: This menu is protected by password and it is for Factory Settings

Exit: Press OK (◀↵) to return to normal working display

NOTE: After 3 seconds the display returns to the main screen.

LCD DISPLAY MESSAGES – Info MENU:

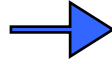

Press Ok (◀↵) button, move with down and up arrow

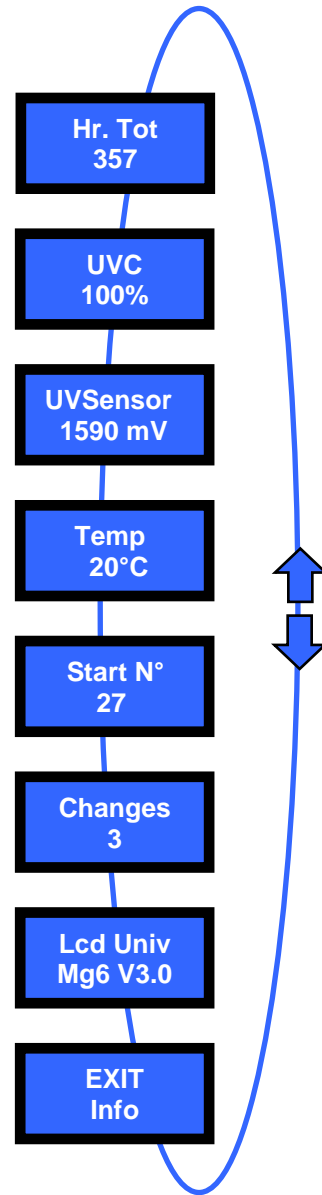
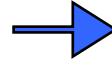

- Hr. Tot:** Displays the system working hours
- UVC:** Displays the UVC Intensity (only LCD PLUS)
- UVSensor:** Displays the signal coming from the UV sensor (only LCD PLUS)
- Temp:** Displays the water temperature (only LCD PLUS)
- Start N°:** Displays the number of start up
- Changes:** Displays the number of lamp changes
- Software Rev:** Displays the software revision
- Exit Info:** Press OK (◀↵) to return to normal working display

NOTE: The display does not return automatically to the main screen. Therefore the user can let the chosen screen as standard visualizing.

LCD DISPLAY MESSAGES – Settings MENU:

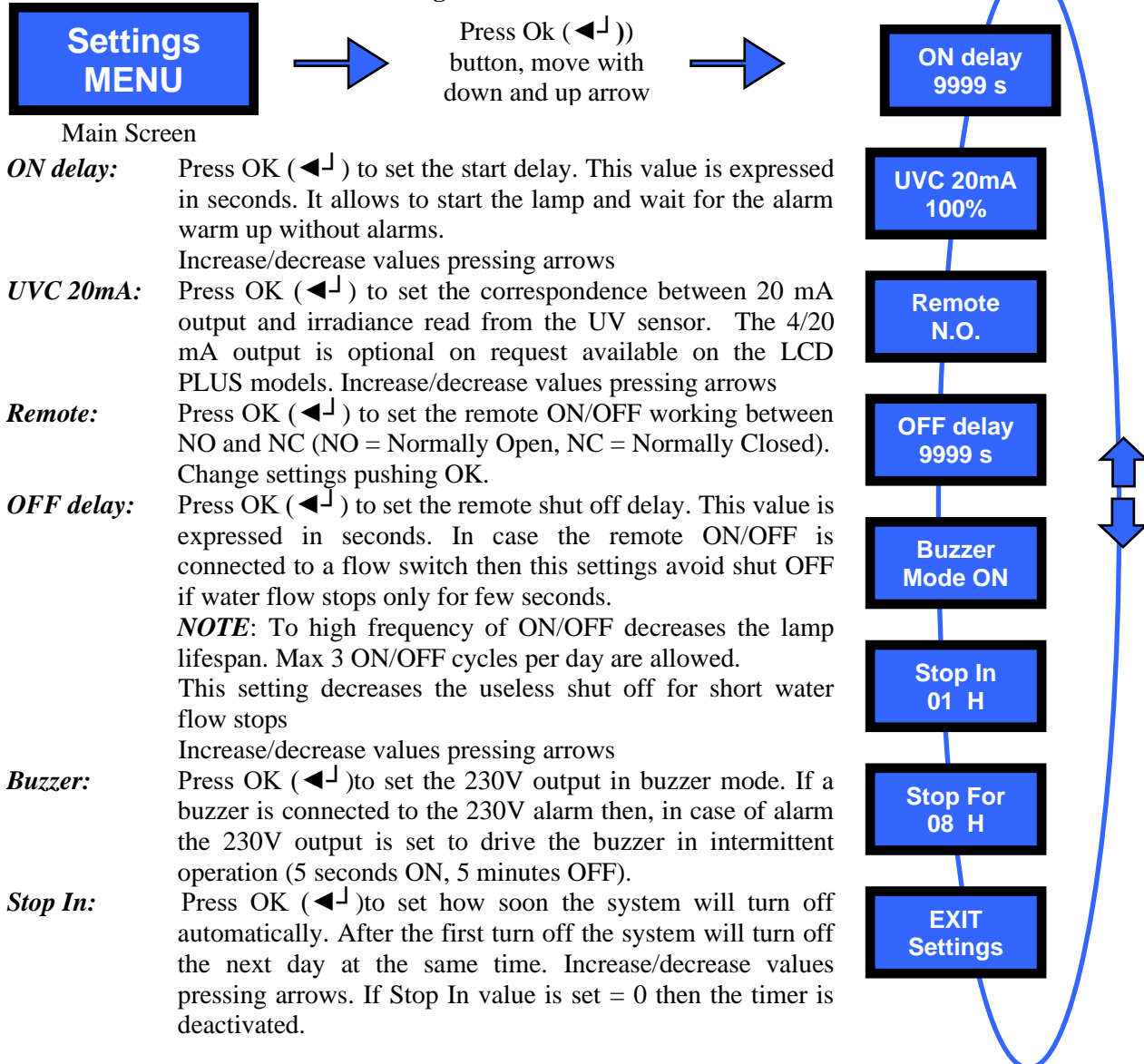

ON delay: Press OK (◀↵) to set the start delay. This value is expressed in seconds. It allows to start the lamp and wait for the alarm warm up without alarms.
Increase/decrease values pressing arrows

UVC 20mA: Press OK (◀↵) to set the correspondence between 20 mA output and irradiance read from the UV sensor. The 4/20 mA output is optional on request available on the LCD PLUS models. Increase/decrease values pressing arrows

Remote: Press OK (◀↵) to set the remote ON/OFF working between NO and NC (NO = Normally Open, NC = Normally Closed). Change settings pushing OK.

OFF delay: Press OK (◀↵) to set the remote shut off delay. This value is expressed in seconds. In case the remote ON/OFF is connected to a flow switch then this settings avoid shut OFF if water flow stops only for few seconds.

NOTE: To high frequency of ON/OFF decreases the lamp lifespan. Max 3 ON/OFF cycles per day are allowed. This setting decreases the useless shut off for short water flow stops
Increase/decrease values pressing arrows

Buzzer: Press OK (◀↵) to set the 230V output in buzzer mode. If a buzzer is connected to the 230V alarm then, in case of alarm the 230V output is set to drive the buzzer in intermittent operation (5 seconds ON, 5 minutes OFF).

Stop In: Press OK (◀↵) to set how soon the system will turn off automatically. After the first turn off the system will turn off the next day at the same time. Increase/decrease values pressing arrows. If Stop In value is set = 0 then the timer is deactivated.

Stop For: Press OK (◀↵) to set how long the system will remain off before automatic restart. Increase/decrease values pressing arrows. If Stop In value is set = 0 then the timer is deactivated.

Timer Diagram example with Stop In set to 4 hours and Stop For set to 10 hours:

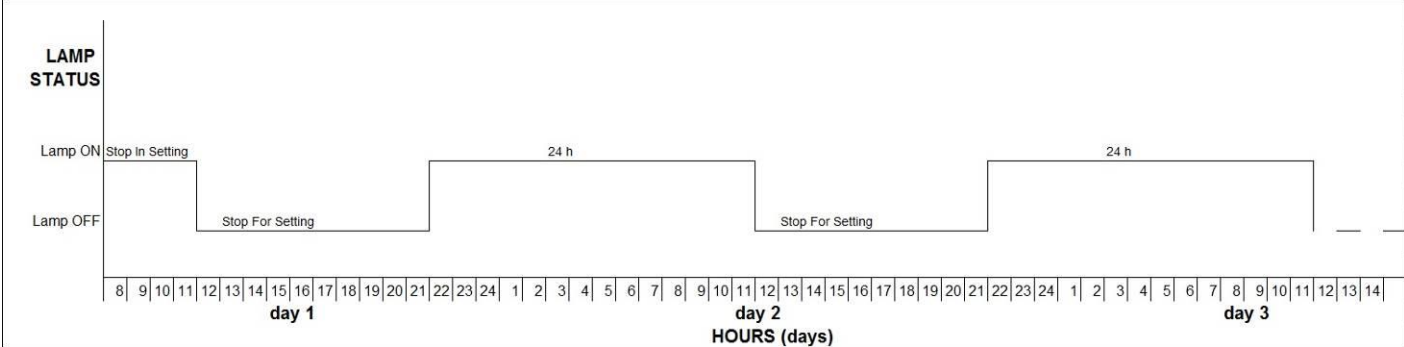

Exit: Press OK (◀↵) to return to normal working display

NOTE: After 3 seconds the display returns to the main screen.

LCD DISPLAY MESSAGES – Sensor Calibr. (Only PLUS version):

This operation must be done at the first start up and on every lamp replacement, with quartz sleeves and sensor measuring window clean. Wait 5 minutes from the lamp start before operating the sensor calibration.

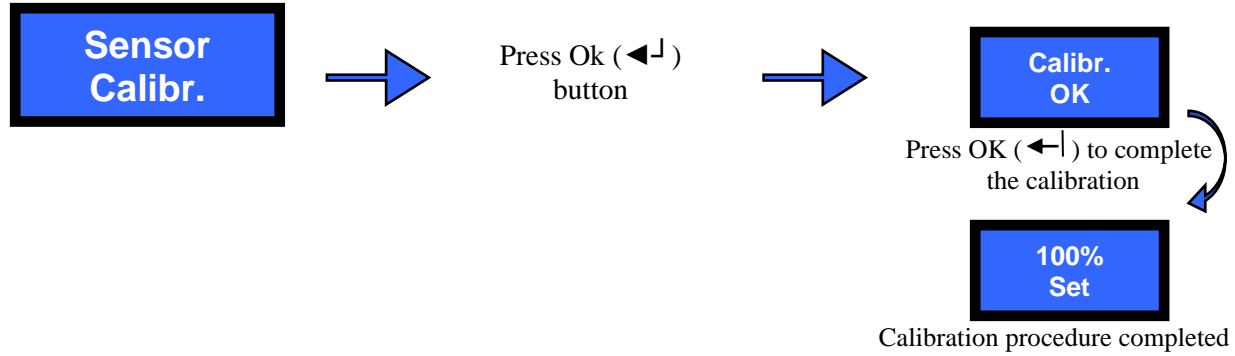

LCD DISPLAY MESSAGES –Reset Hr Lamp.:

This operation starts the count down of the lamp life hour meter. This operation must be done at the first lamp start and on every lamp replacement

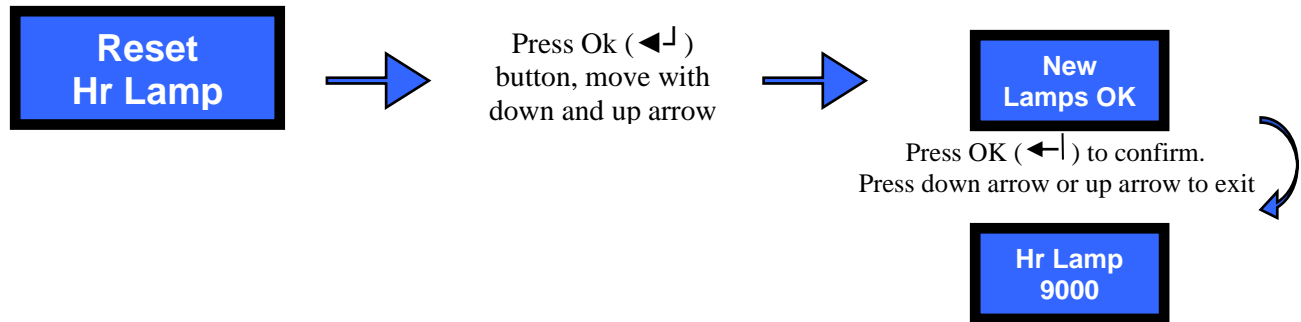

LCD DISPLAY MESSAGES – Alarms/troubleshooting:

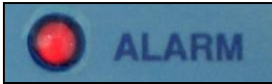

In case of any alarm the red LED is flashing.

List of alarms:



Indicates the lamp failure. If the system has 2 lamps the failed lamp is identified. Check:

- Connection to the lamp
- If lamp has failed
- If lamp electronic driver has failed.



Indicates that the count-down hour meter of lamps life comes to zero. In such case replace the lamps and restart lamp hour.

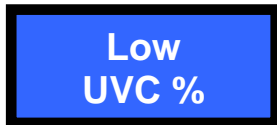

Indicates low irradiation. Check:

- If lamp life has expired
- If quartz sleeves are dirty
- If sensor windows is dirty
- If water quality has changed

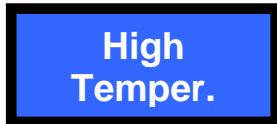

Indicates high temperature in the UV chamber. This may happen when either there is no flow or there is air in the UV chamber. In such cases the system switches off.

Reset the alarm: Push OK(◀↵) for 5 sec to put the system in standby then press OK (◀↵) again to restart the UV system.

NOTE: In case of high temperature the panel turns off the lamp and this remains off even if temperature drops below the threshold level. This is necessary in case of no flow to avoid this cycling:

Lamp ON→ High Temperature→lamp turned off→Temperautre lower then threshold→ lamp started again→ High Temperature→....

This can destroy the UV lamp, in case the user can accept this risk then ask the factory for setting change instructions.

LCD DISPLAY MESSAGES – Other Problems:



Display OFF in case of no electrical feeding or burned fuses

7. Electrical Panel Description

7.1 External View

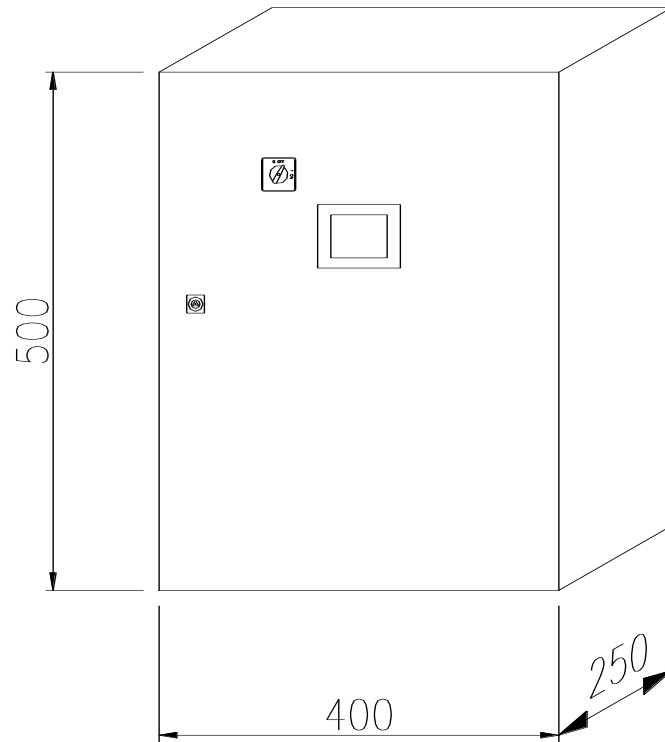

7.2 Internal View and Electrical Components

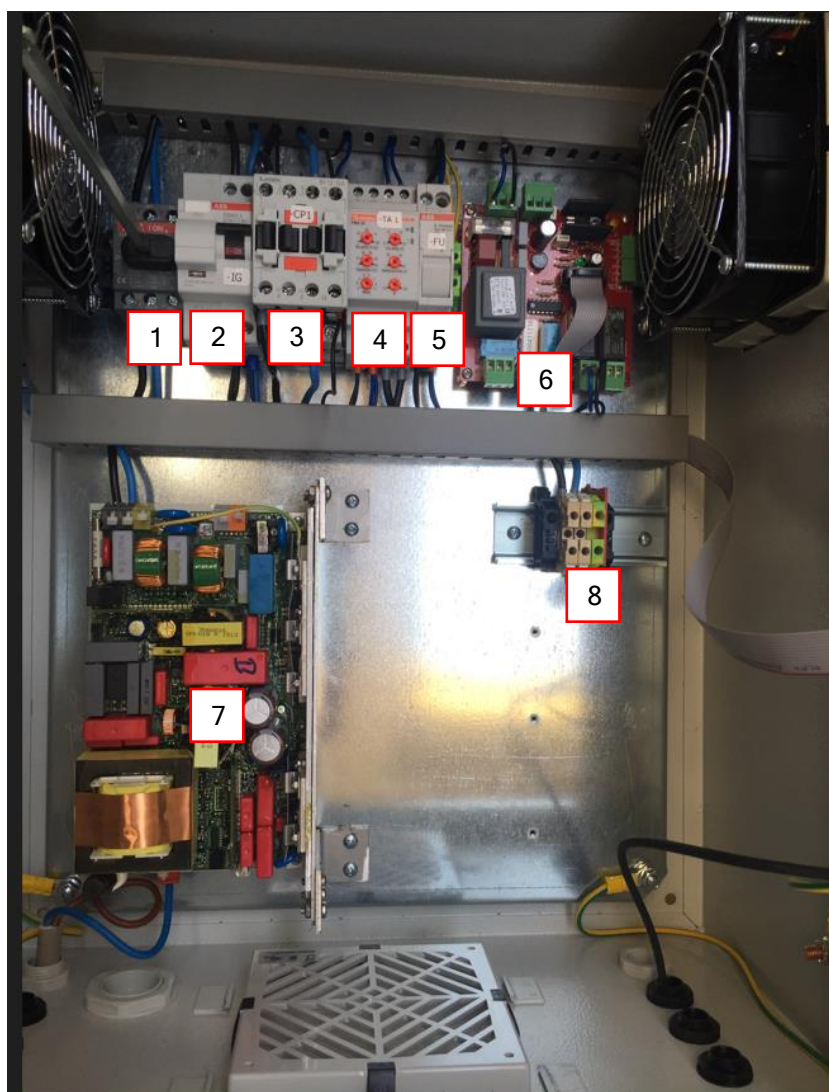

ARTICLE	N°
Isolator Switch	1
Protection Switch	2
Lamp Driver Power Contactor	3
Lamp Current Relay	4
Fan Fuse Holder	5
UV665MS control board	6
MP1295 Lamp Driver	7
Power + Remote ON/OFF Terminals	8

7.3 Mains Power Connections/ Input-Output Terminals

See annex to the manual

8. Reactor Dimensions

a.SMP 7 ECO

(see the attachments to the manual)

9. Technical Data Sheet

a.SMP 7 ECO

(see the attachments to the manual)

10. Maintenance

Maintenance work may only be carried out by personnel who have been trained and authorized for this work by the owner and/or user. The owner and/or user must ensure that the maintenance personnel are familiar with the safety measures and regulations, and that they also comply with them, in addition to having read and understood the operating instructions.

Only original replacement parts from the supplier must be used.

The following are the recommended service intervals for replacement parts:

- | | |
|---|---|
| ✓ <u>UV Lamp:</u> | Replacement every 10.000 h. |
| ✓ <u>Quartz sleeve:</u> | Clean every week, replacement depends on wear |
| ✓ <u>O-Rings:</u> | Replacement every year. |
| ✓ <u>Control Panel filter mat:</u> | Replacement or cleaning every year |

Replacement of the UV lamp

UV Replacement must be done when the Partial Hour Timer display 10000 hours.

Operations:

1. Switch off the electrical panel. Check that the main power supply is isolated to the control panel.
2. Make sure that the power has been isolated or that the UV lamp has been OFF for at least 15 minutes before carrying out the following procedure. This is to ensure that any residual heat on the lamp has been dissipated.
3. Screw out the ring nuts.
4. Short-circuit the feeding cable (for example with a screwdriver) to run down the capacitor.



ATTENTION: Do not touch the feeding cable without creating a short circuit

5. Screw out the ceramic terminal that secure the lamp terminal plate to the reactor glad nut.
6. Visually check the internals of the vessel sleeve for any signs of cracking or water leakage that could have occurred during operation.

INFORMATION: *The UV lamp glass and quartz sleeve must never be handled with a bare hand. When handling the glass, clean white cotton gloves must always be worn.*

7. Insert the new lamp, securing with the fixing ceramic terminal.
8. Block by screwing the ring nuts on the sleeve bolts.
9. Ensure that the fixing screws are re-fitted as they form the Earth connection for the cover.
10. Reset the Partial Hours (See Section “Reset Partial Hours”)
11. Calibrate the sensor (See Section “Calibrate the sensor”).

Clean the quartz sleeve (SMP Model)

Clean must be done every month (suggested range 1 week) to preserve the correct working of the system. The UV system is provided with a manual cleaning system piston.

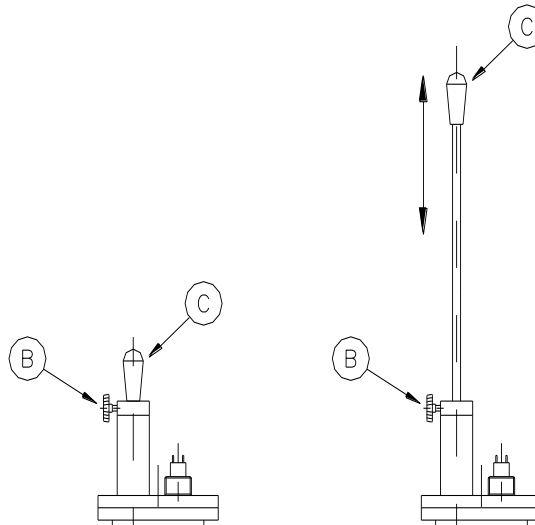

Cleaning procedure:

Unscrew the B screw (this screw blocks the cleaning bar in standard working)



ATTENTION:

If the chamber is pressurized: After the B screw is unscrewed the piston will lift because of the water pressure.

Move UP and DOWN the cleaning bar using the C handle. The number of cleaning cycles depends on the water quality. When the cleaning is finished, block the cleaning bar with the B screw.

Replacement of the quartz sleeve

The replacement of the quartz sleeve must be done only if its wear compromises the correct working of the systems. It depends on the quality of the water.

Operation:

1. Switch off the electrical panel. Check that the main power supply is isolated to the control panel.
2. Make sure that the power has been isolated or that the UV lamp has been OFF for at least 15 minutes before carrying out the following procedure. This is to ensure that any residual heat on the lamp has been dissipated.
3. Screw out the ring nuts.
4. Remove the UV lamp.

INFORMATION: *The UV lamp glass and quartz sleeve must never be handled with a bare hand. When handling the glass, clean white cotton gloves must always be worn.*

5. Stop the flow of water through the reactor by operating the by-pass valve or by stopping the main circulation pump(s) and drain the water in the reactor.
6. Screw out the sleeve bolts and take the o-ring.
7. Remove the quartz sleeve and change it with the new one.

INFORMATION: *The quartz sleeve must never be handled with a bare hand. When handling the glass, clean white cotton gloves must always be worn.*

INFORMATION: *Insert the new quartz sleeve, taking care to ensure that it locates through the scraper ring.*

8. Place the O-Ring between the quartz sleeve and the sleeve bolt.
9. Insert the gasket in the sleeve bolt and screw the sleeve bolt to fix the quartz sleeve.
10. Insert the lamp and connect it as described before.
11. Slowly open the water isolating valves and slowly flood the reactor with the water (vent the reactor). Check the o-ring seal and sleeve for signs of leakage
12. Turn on the electrical panel.

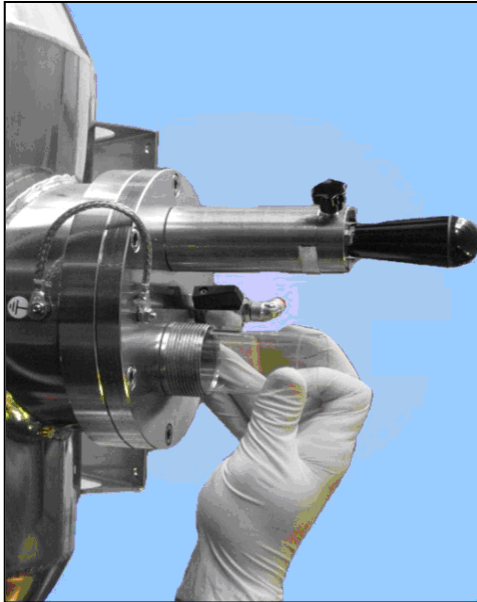

Insert the quartz sleeve in the chamber (point 7)

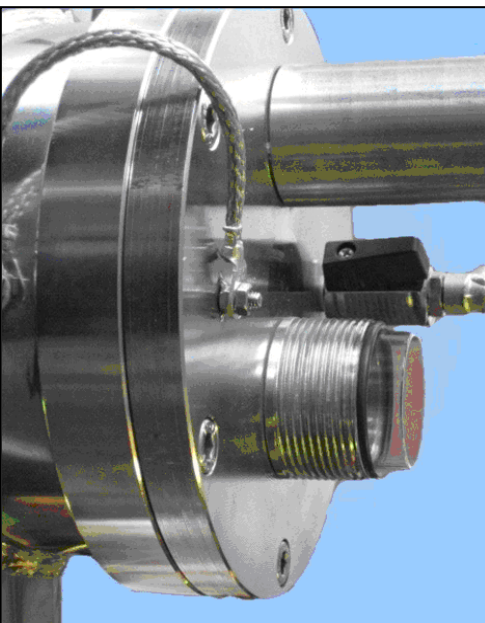

Insert the o-ring on the sleeve (point 8)

Insert the gasket in the sleeve bolt (point 9).



Screw the sleeve bolt (point 9)

Replacement of the fan filter

Depending on the environment where the control panel is installed, the filter fitted to the inlet fan grills must be cleaned or changed on a regular basis. It is recommended that after commissioning, the filter mat is checked on a monthly basis. Thereafter, depending on the results of these checks this could be reduced to between 3 to 6 months.

11. Spare Part Lists

Relevant spare part lists

RIF. REF.	DESCRIZIONE DESCRIPTION	CODICE CODE
A	LAMPADA UV / UV LAMP SMP 7-11	MP1426
	LAMPADA UV / UV LAMP SMP 22	MP1427
	LAMPADA UV / UV LAMP SMP 33	MP1428
B	GUAINA AL QUARZO / QUARTZ SLEEVE SMP 7-11	MP1405
	GUAINA AL QUARZO / QUARTZ SLEEVE SMP 22	MP1400SV
	GUAINA AL QUARZO / QUARTZ SLEEVE SMP 33-44	MP1409
C	SENSORE Ø 1/4" / SENSOR Ø 1/4"	MP1128
D	BLOCCAGUAINA / SLEEVE BOLT	026425316
E	MORSETTO DI CERAMICA / CERAMIC CLAMP	UV752
F	GUARNIZIONE PER ALBERO / GASKET FOR MAST	R105
G	DISCO TEFLON Ø38 / TEFLON DISK	MP1137/TRM
H	O-RING 2112	OR2112
I	ADATTATORE QUADRIPIN / FOUR PINS ADAPTOR	026431
L	GHIERA / NUT	026426
M	O-RING 38x4	028207
N	O-RING 3500 (SMP 7-11-22-33-44)	028208/A
	O-RING 4825 (SMP 50-70-105)	028214
	O-RING 3975 (SMP 140)	MP1142
	O-RING 41200 (SMP 175)	028215
P	GUARNIZIONE / GASKET	026425G
Q	SENSORE TEMPERATURA / TEMPERATURE SENSOR (TC ONLY)	2920.2

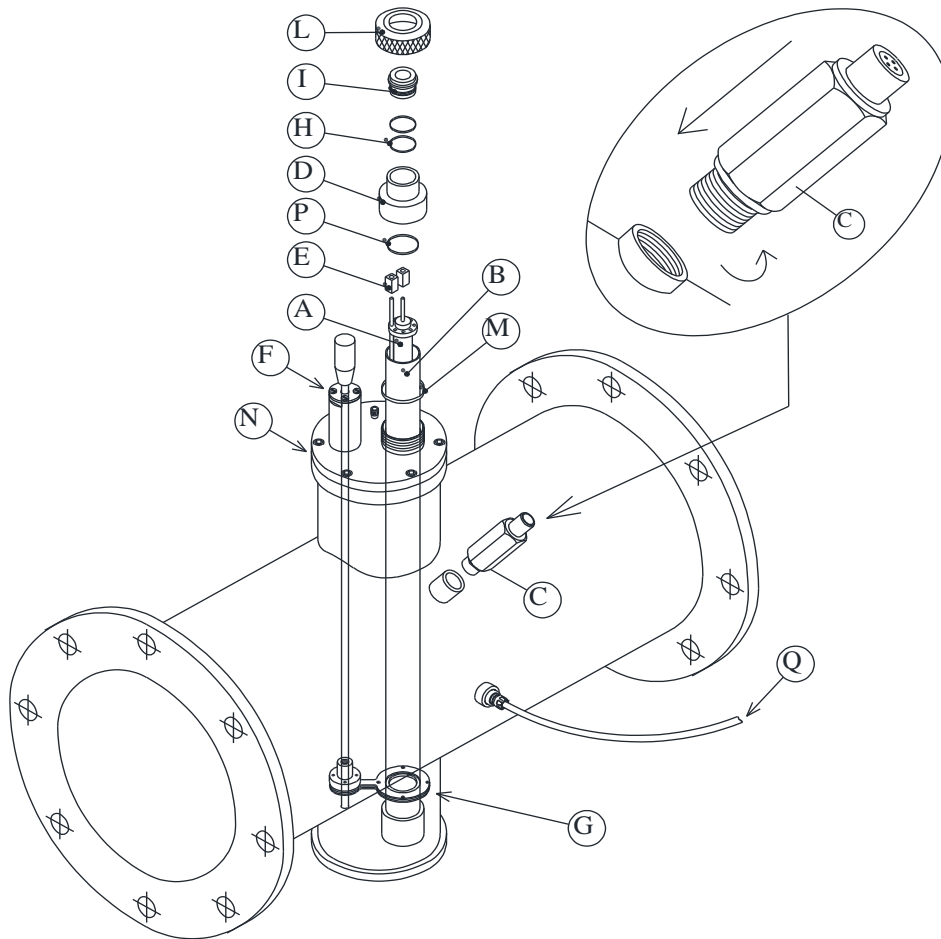

RIF. REF.	DESCRIZIONE DESCRIPTION	CODICE CODE
A	DISCO TEFLON $\varnothing 38$ / TEFLON DISK $\varnothing 38$	MP1137/T
B	DISCO TEFLON / TEFLON BUSH	R102/E
C	O-RING 3150 / O-RING 3150 TYPE	MP1156
D	BOCCOLA $\varnothing 45$ / BUSH $\varnothing 45$	R080/1
E	MOLLA / SPRING	R082
E	TENUTA MECCANICA / MECHANICAL SEAL	R083
F	CUSCINETTO / BEARING	R079
G	DISCO $\varnothing 45 \times 23$ / DISK $\varnothing 45 \times 23$	R080
H	GIUNTO / COUPLING	MP1170K
I	GUARNIZIONE / GASKET	R105
L	FINECORSA MECCANICO / MECHANICAL LIMIT SWITCH	2914
M	FINECORSA MAGNETICO / MAGNETIC LIMIT SWITCH	2913
N	SENSORE T. (OPTIONAL) / T. SENSOR (OPTIONAL)	2920
O	ANELLO RASCHIATORE / WIPER DISK	MP1137/GN

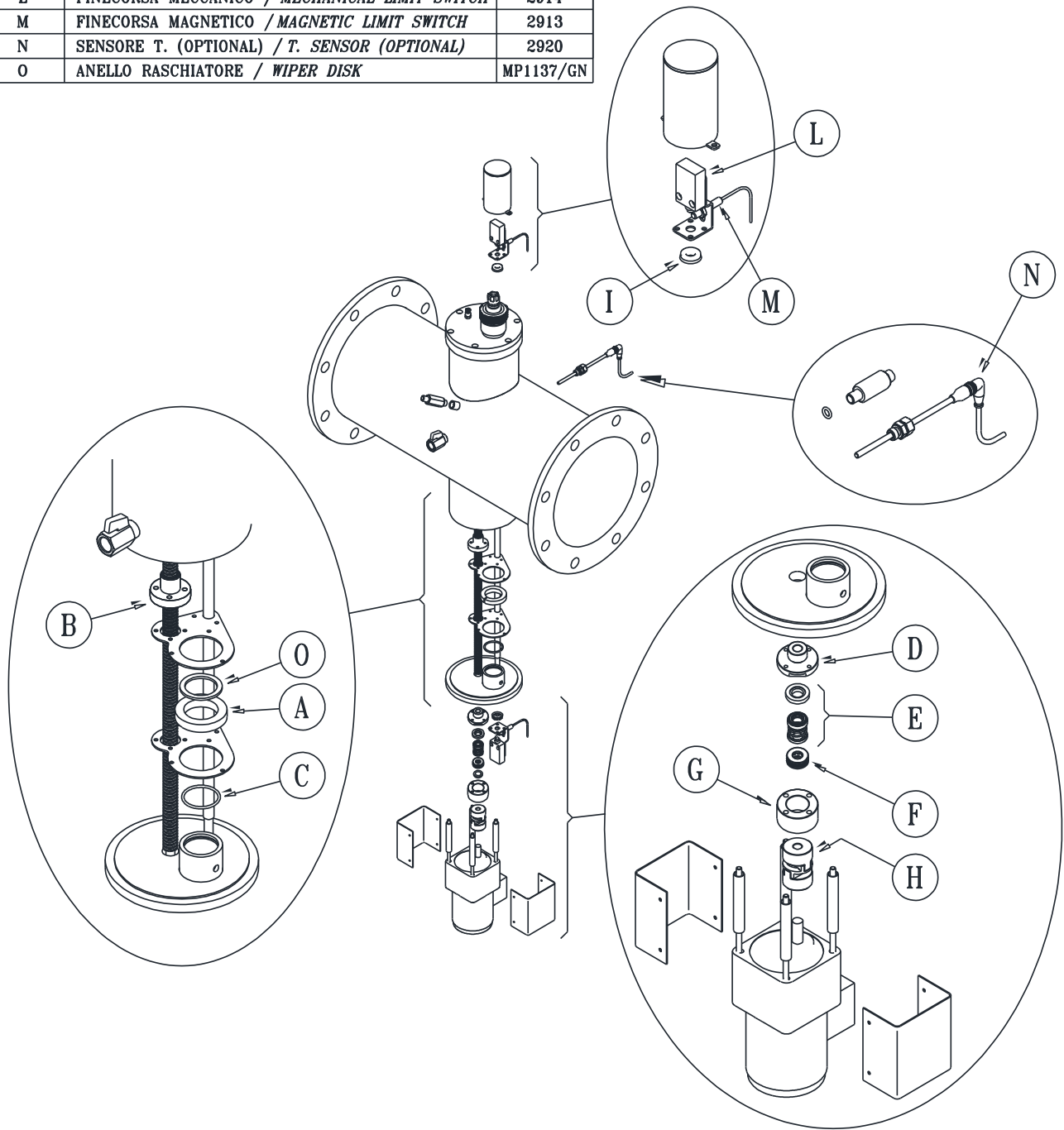

13. Electrical Panel Spare Parts

Details of all the relevant electrical control panel components are contained in the electrical drawings (see the attachments to the manual).

14. Electrical Diagram

(see the attachments to the manual)

15. Warranty Conditions

WARRANTY CONDITIONS EX ART. 1490 C.C.
--

SITA works in compliance with ISO-9001:2015 quality procedures and subjects all equipments to accurate checks and tests.

The equipments are covered by warranty for 24 months from the date of purchase, while the stainless steel chambers are guaranteed 5 years for manufacturing defects.

Our Company engages itself to repair or replace without charge those parts which should prove to be non efficient, upon its judgement.

The warranty does not cover:

- Accidental breakages due to the transport
- Accidental breakages due to the uncorrect use or to carelessness
- Breakages due to the connection to a power grid feeded with a tension different from the forecast one ($\pm 10\%$ of the nominal value, as fixed by the CEI rules)

The warranty does not cover the product repaired or tampered by non-authorized third party, and the product on which an intervention has been made for defect or for convenience tests.

In no case the integral replacement of the product is foreseen and no request for indemnities for eventual damages undergone will be recognized.

Repairs are normally carried out in our warehouse or in authorized after-sales service centers.

DO NOT TAMPER THE ADHESIVE LABELS FOR QC IDENTIFICATION!

- The adhesive label with the number of QC (Quality Control) indicates the form of the electrical test specific for that unit, which, upon request, can be sent to the Customer.
- The adhesive label with the S/N (Serial Number) number must be intact and readable; such number allows to enter the data bank of tests and to find the values obtained in the hydraulic test of the equipment.

16. Declaration Of Conformity

Unit produced in the factory of:

S.I.T.A.
Italian Company for Water Treatment

EC DECLARATION OF CONFORMITY

The undersigned hereby declares, under full responsibility, that the unit:

UV DISINFECTION SYSTEM
SMP 7 ECO 230 MODELS

IS IN COMPLIANCE WITH

- 2014/35/EU (low voltage directive)
- 2014/30/EU (electromagnetic compatibility)
- 2015/863/EU (RoHS³)
- 2012/19/EU (WEEE)
- IEC-EN 60204-1 norms (safety of machinery-electrical equipment of machinery)
- IEC -EN 55016-2 norms (methods of measurement of disturbances and immunity - conducted disturbance measurements)
- Directive (EU) 2020/2184 (on the quality of water intended for human consumption)
- Regulation (EC) No 1935/2004 (on materials and articles intended to come into contact with food)
- 2014/68/EU (art.4 comm.3) (PED)

The validity of CE marking is subordinated to the equipment integrity. Any modification, if not authorized, will cancel the use of the CE marking. This will occur in case the relevant risks have not been previously analyzed by our company, and a new EC Declaration of Conformity has been issued.