

TABLE OF CONTENT

PAGE	
2	1. SAFETY WARNINGS
3	2. SAFE POOL SANITIZING WORKING PRINCIPLE
	2.1 WATER CHEMISTRY
	2.2 CHLORINE LEVEL CALCULATION
	2.3 SALT LEVEL
	2.4 TYPE OF SALT
	2.5 ADDITION AND REMOVING SALT IN THE SWIMMING POOL WATER
5	3. PRODUCT FEATURES
	3.1 PRODUCT DIMENSIONS
	3.2 PRODUCT SPECIFICATION
7	4. INSTALLATION GUIDE
8	5. START UP
9	6. CONTROL PANEL OPERATION
	6.1 DIGITAL DISPLAY
10	7. TIMER SETTING FOR TIMER VERSION
11	8. MAINTENANCE AND TROUBLESHOOTING
11	9. TROUBLE SHOOTING
12	10. ELECTRICAL WIRING
	10.1 MAIN PCB
	10.2 POWER MODULE
	10.3 TRANSFORMER
	10.4 TERMINAL BLOCK
13	11. CLEANING THE TITANIUM CELL
14	12. TERMS OF THE WARRANTY

1. SAFETY WARNINGS



This appliance must be installed in accordance with national wiring codes and with a means of disconnection incorporated in any fixed wiring.

High voltage can shock, burn, or cause death or serious property damage.

1. In order to reduce the risk of electric shock DO NOT use an extension cord to connect the unit to electric supply.
2. If the supply cord is damaged, it must be replaced by the manufacturer, its service agent or a qualified electrician.
3. The system must be permanently connected to an individual circuit breaker, especially when pump power is connected from pump socket of the device.
4. This electricity supply must be connected through a residual current device (RCD) or Ground Fault Circuit Interrupter (GFCI) with a rated residual operating current not exceeding 30 mA.
5. Electrical grounding must be connected before connecting to electrical power. Failure to ground all electrical equipment can cause electric shock or serious or fatal injury.
6. Before servicing, unplug the power plug from the electrical socket and allow the device to cool for at least 15 minutes.
7. Never unplug the cell cable during operation.



This appliance can be used by children aged from 8 years and above and persons with reduced physical, sensory or mental capabilities or lack of experience and knowledge if they have been given supervision or instruction concerning use of the appliance in a safe way and understand the hazards involved. Children shall not play with the appliance. Cleaning and user maintenance shall not be made by children without supervision.



HYPERTHERMIA

Always unplug the device from its socket or power source and allow it to cool before opening the enclosure. There is high risk of shock and burn injuries from touching the internal component.

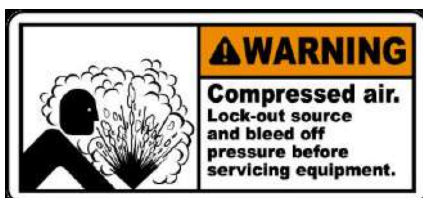

COMPRESS AIR HAZARDOUS

This system enclosed titanium cell in a plastic enclosure that can become pressurized. Pressurized air can cause the plastic enclosure to explore causing serious injury or death. The cell must be operated with the pump running and the valves fully open allowing water to flow unrestricted through the cell enclosure.



This device is intended for use with swimming pools and spas only; it must not be used for disinfecting drinking water.

Only one pump and one underwater light may be connected to this unit (SSC-TLT Series Only)
The current loading of the pumped connected must not exceed 8 Amp. (SSC-TLT Series Only)

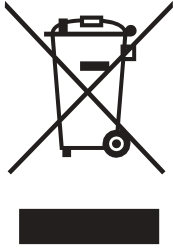
	Correct disposal of this product
	<p>This symbol on the product, or in its packaging, indicates that this product may not be treated as household waste. Instead, it should be taken to the appropriate waste collection point for the recycling of electrical and electronic equipment. By ensuring this product is disposed of correctly, you will help prevent potential negative consequences for the environment and human health, which could otherwise be caused by the inappropriate waste handling of this product. For more detailed information about the recycling of this product, please contact your local council, your household waste disposal service, or the shop where you purchased the product.</p>

2. SAFE POOL SANITIZING WORKING PRINCIPLE

Chlorine is a highly effective sanitizing agent which is commonly used in swimming pools. It can prevent the growth of bacteria and fungi. This chlorinator uses the process of electrolysis to break down the salt (NaCl) in the swimming pool water to produce chlorine gas (Cl₂). Chlorine production can be regulated from the control unit by altering the electric current flowing through the titanium electrode in the cell housing.

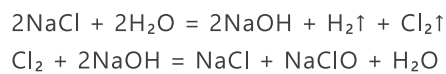

2.1 WATER CHEMISTRY:



It is important to note that the EMAUX Chlorinator does not maintain the water chemistry of your swimming pool water; it simply produces chlorine from a mild salt solution.

To ensure that your chemical balances is within the guidelines listed below and to encourage a sparkling clean, you should also have your water tested regularly at your local pool shop.

Salt level	SSC15-E / SSC15-T / SSC15-TLT	3000 - 4000 ppm
	SSC25-E / SSC25-T / SSC25-TLT	3000 - 4000 ppm
	SSC50-E/SSC50-T	4000 – 5000 ppm
Free Chlorine	1.0 – 3.0 ppm	
pH	7.2 – 7.6	
Cyanuric acid (stabilizer)	30 – 50 ppm	
Total Alkalinity	80 – 120 ppm	
Calcium Hardness	200 – 400 ppm	
Metals	0ppm	

2.2 CHLORINE LEVEL CALCULATION

$$\text{Required Chlorine Production Rate (g/hr)} = \frac{\text{Pool Volume (litre)} \times \text{Standard Chlorine (g/litre)}}{\text{Turnover Rate (Hr)}}$$

Standard chlorine level not less than 2mg/liter = 0.002g/liter

Example:

Pool volume: 65m³ = 65,000 litre

Turnover rate: 4 Hour

$$\text{Required chlorine production rate (g/hr)} = \frac{65,000 \text{ liter} \times 0.002\text{g/liter}}{4 \text{ Hr}} = 32.5\text{g/hr}$$

2.3 SALT LEVEL

The amount of salt required is between 4000 and 6000 ppm. This can be done by adding 4-6Kg of salt per 1,000 litres of water directly into the pool water.

A low concentration of salt (below 2500 ppm) will cause premature cell failure.

A High concentration of salt (above 6000 ppm) may cause electro-oxidation and corrosion damage to the Stainless Steel pool fixtures and fittings.

Salt required according to the volume of the pool:

Pool volume (m ³)	Salt (kg)	Pool volume (Gallon)	Salt (Pound)
10	40	2,642	88
15	60	3,963	132
20	80	5,283	176
25	100	6,604	220
30	120	7,925	264
35	140	9,246	308
40	160	10,567	352
50	200	13,209	440
60	240	15,850	528
70	280	18,492	616
80	320	21,134	704
90	360	23,775	792
100	400	26,417	880
110	440	29,059	968
120	480	31,700	1,056
150	600	39,626	1,320

Note: Table based on 4000 ppm of salt per m³ of water.

2.4 TYPE OF SALT

The most common salt used in swimming pools with Salt Electrolysis is 99% pure Sodium Chlorine (NaCl).

DO NOT use the following types of salts:

1. Rock salt.
2. Salt with more than 1% yellow prussiate of soda.
3. Salt with more than 1% of anti-caking additives.
4. Iodized salt.

Salt with additives or impurities will cause premature cell failure.

2.5 ADDITION AND REMOVING SALT IN THE SWIMMING POOL WATER

Before adding the salt into the pool, place the multiport valve on "Filtration" or "Recirculation" and then turn the filtration pump on.



Add the salt directly into the pool evenly around the pool or ballast tank. Do not allow the salt to sit in a pile on the bottom of the pool.

Do not add large amount of salt nearby the skimmer at the same time. It will damage the unit.

Keep the filtration system running for 24 hours using the Main Drain or vacuum suction nozzle as a main suction line. The only way to remove the salt in the pool water is to partially drain the pool and refill with fresh water.

3. PRODUCT FEATURES

1. Convenience and the constant delivery of pure chlorine-based sanitizer.
2. No more artificial chemical cleaning agent which could cause skin and eye irritation. You just need to add natural salt in the pool.
3. The salt in the water is so little you do not taste or smell the salt.
4. The electrode is made of titanium, which is durable and resistant to corrosion.
5. Easy to install and operate.
6. The water does not have the heavy smell of chlorine because chlorine is not directly added to the pool.

Product Picture

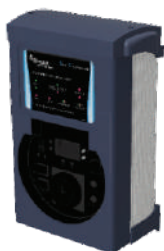

1 x control box



1 x cell unit



1 x cell cable



1 set screws and Fuse



1 set 1.5" & 2" Universal Union

User Manual

3.1 PRODUCT DIMENSIONS

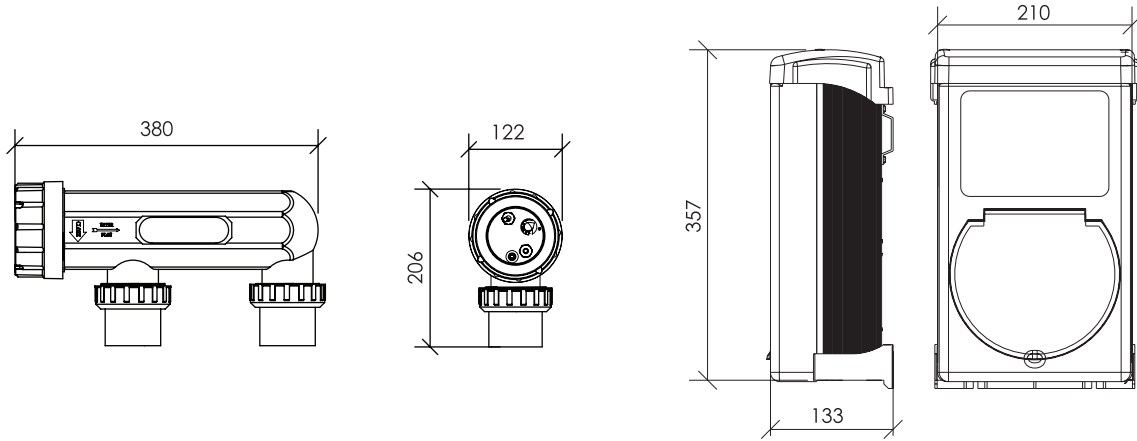

3.2 PRODUCT SPECIFICATION

Model	Cell power Rating (VA)	Chlorine Generation (g/hr)	Fiberglass Pool (Liter)	Concrete Pool (Liter)
SSC15-E	142	15	50000	45000
SSC25-E	226	25	75000	70000
SSC50-E	500	45	120000	110000
SSC15-T	142	15	50000	45000
SSC25-T	226	25	75000	70000
SSC50-T	500	45	120000	110000
SSC15-TLT	142	15	50000	45000
SSC25-TLT	226	25	75000	70000

All the cells are Self Cleaning type

SSC-TLT Series (Chlorinator with underwater light, transformer and time switch)

Model	Input Voltage / Frequency	Underwater light transformer Power Rating
SSC15-TLT	220-240VAC 50/60Hz	100VA
SSC25-TLT	220-240VAC 50/60Hz	100VA

SSC-T Series (Chlorinator with time switch)

Model	Input Voltage / frequency	Power Rating
SSC15-T	220-240VAC 50/60Hz	142VA
SSC25-T	220-240VAC 50/60Hz	226VA
SSC50-T	220-250VAC 50/60Hz	500VA

4. INSTALLATION GUIDE

The Emaux SSC Chlorinator unit is contained in a rain tight enclosure that is suitable for outdoor mounting (IPX4 waterproof). However, the following points must be taken into consideration for a correct installation of the Superior SSC Chlorinator unit:

1. Select a convenient well-ventilated location within one meter of filter equipment.
2. The cell must be installed above the sand filter discharge outlet water level.
3. If the chlorinator and cell are installed below water level, the pump and chlorinator must have a common power switch in order to prevent the chlorinator from generating chlorine while the pump is not running. Otherwise the cell enclosure will overheat and explode if only the pump is shut off.

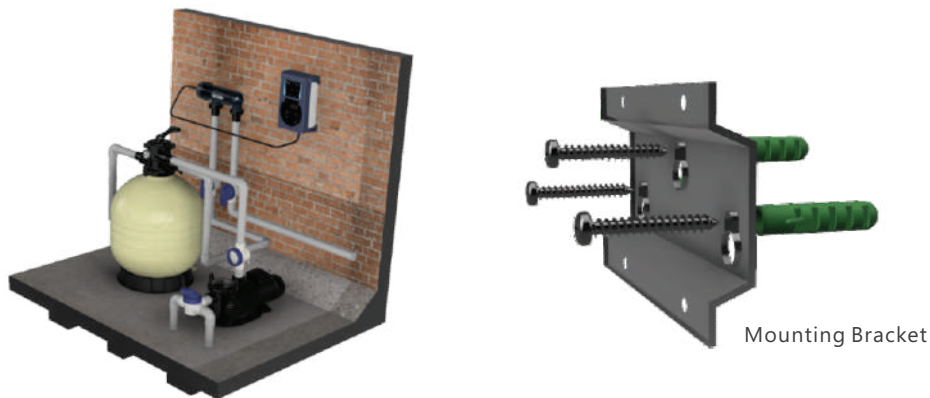

Typical system installation and Cell location with gate valve and water flow direction

4. Install the Control Panel using the template paper sheet provided with the package in a minimum distance of 3.5 meters (11.5 ft.) from the swimming pool, 1.5 meters (5 ft.) from the ground, within 2 meters (6.5 ft.) from the protected outlet, and within 4.5 meters (15 ft.) from where the cell will be installed, in a ventilated area and leaving enough free space of min. 50 cm (20") in each side for servicing.
5. Two self-tapping screws and wall plugs are provided for fast and simple installation. Simply cut out the template provided for the location of the drilling points. Use a 8mm masonry drill when fitting the control unit to a brick or concrete wall. When mounting to a post, drill pilot holes and fit the screws provided. Once the screws are in position simply hang the chlorinator via the bracket on back of the control box.
6. The cell must be installed horizontally
7. The electrolytic cell housing must be plumbed into the return line after the filter. The cell housing can be fitted to 1.5: or 2" PVC piping by provided universal union.
8. Connect the water inlet and outlet to the Cell Unit. The water flow direction must be as indicated on the Cell.
9. To avoid loss of chlorine, the Cell should be installed at the end of the filtration system, right before the pool water return.
10. The cell should preferably be installed on a bypass with input and output gate valves. This will permit uninterrupted filtration while the chlorinator is being serviced. The inlet and outlet valves must not be closed during operation, otherwise pressure will build up in the plastic enclosure and it will explode.
11. Glue the salt cell horizontally on the pool return pipe, allow the pipe glue to cure for 24 hours.
12. Use the provided cable to connect the control unit and the salt cell together.

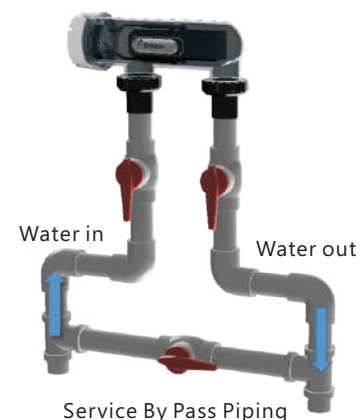



13. For model with power socket for pump, the maximum allowed power rating is 1,500 Watt or 1.5HP. Refer to pump model plate for power rating confirmation.
14. DO NOT mount the Control Panel under direct sun light.
15. The Control Panel must be installed far away from the chemical storage, especially from acid because it can corrode the electronics inside the unit.
16. It must be kept away from heat sources and any equipment which produce heat.
17. Plug-in power supply into a suitable weatherproof outlet socket with circuit breaker.
18. Before fixing the Control Panel, make sure that the power cable and cell cable also reach the Control Panel.

For model with built-in lighting power output:

Mount the control unit vertically onto a post or wall 1.5 meters above ground level. (Australian Standards requires that the electric control unit shall not be located within 3 meters of the pool water.)

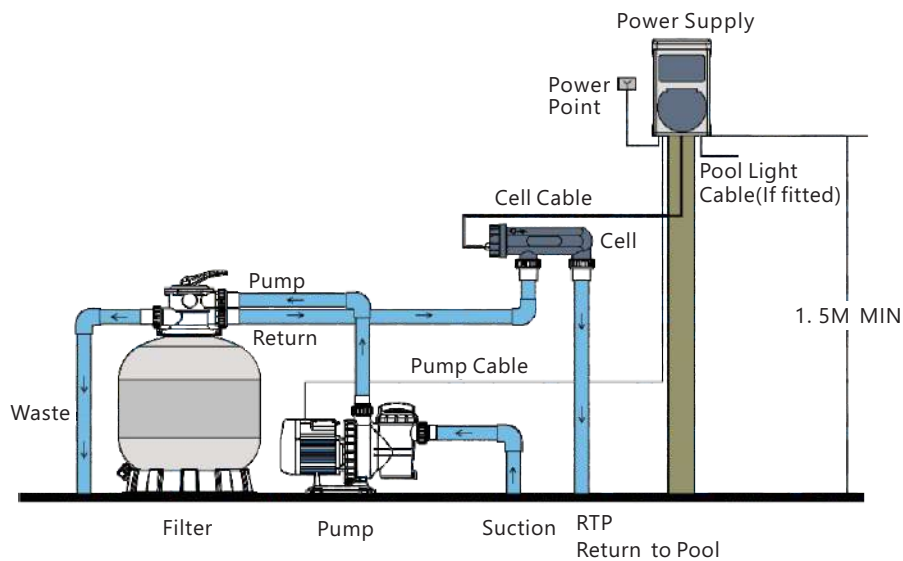

5. START UP



WARNING:

Never allow the chlorinator operate without water flow. The pump and chlorinator must operate simultaneously.

1. Recommended pool salt lever: 3000- 4000PPM for SSC15 and SSC25, 4000-5000PPM for SSC50.
2. Run chlorinator at the Salt Levels stated within this document and on the product to ensure optimum sanitizer output and cell life.
3. Operating this device at low salt levels will damage the cell and reduce its life.

4. The control panel will display a RED indicator when the salt level is low.
5. If no action is taken to rectify the salt level, damage to the cell may result which will not be covered under warranty.
6. During extreme hot weather conditions or high bather load, the pool water need to be super-chlorinated using powder, granulated, or liquid chlorine or the running time of the chlorinator should be increased.
7. Always turn down the system control to zero before adding salt, once the salt is completely dissolved, return to the set position.
8. The aluminum casing at the back of the Control Unit acts as a heat sink, do not touch it with bare hands.

6. CONTROL PANEL OPERATION

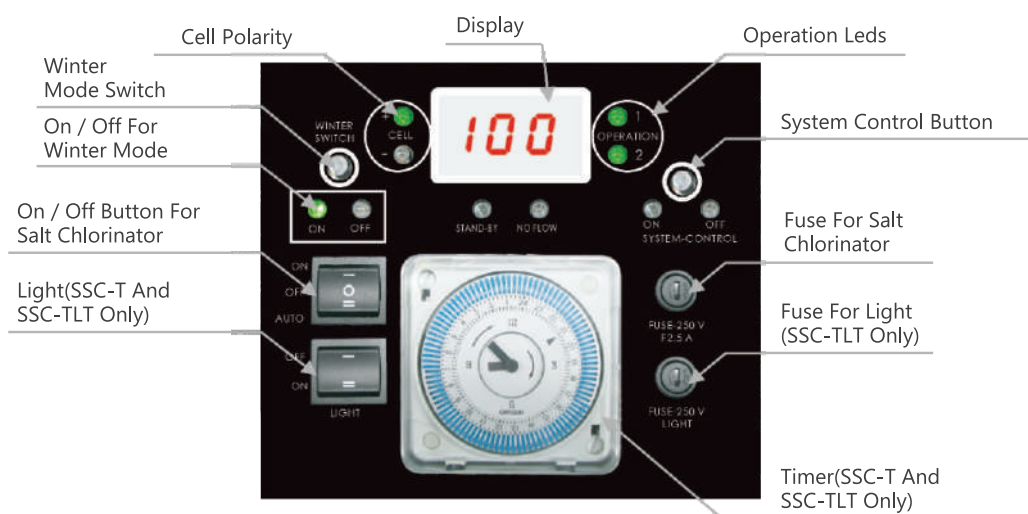

6.1 DIGITAL DISPLAY

There are three display functions:

1. When system control button is tuned from left to right, it adjust the cell output ratio and display the corresponding running time per hour. For example, "100 "means 60 minutes, "50" means 30 minutes run and 30 minutes idle.
2. In normal operation, it represent the percentage of the chlorine production. "100" means 100% chlorine is being generated with adequate salt level.
3. System Error code, system stop and need attention

Error code	Description	Solution
ER2 *	Terminal inside temperature is too high	Switch off. Allow to cool. Open the case to check the cell terminal screw is tight. Restart.
ER3	Thermal sensor is disconnected	Check the sensor cable is not loose.
ER4	AC line input issue	Check the transformer output wiring, or fuse is broken

* ER2- for protection, the system will stop operate when a worst environment is detected, such as too high salt level, high ambient temperature or insufficient ventilation.

LED DISPLAY

	1	2	Description
Operation	Green	Green	Normal Operation
	Green	Red	Low salt/Deposition on the electrode/ Low water Temperature
	Red	Red	Extremely low salt level / heavy deposition on the electrode /extremely low water temperature
System Control	ON	OFF	Description
	Green		System control less than 100%, under operating
		Red	System control less than 100%, under idle time
Cell Polarity	+	-	Description
	Red		The cell current in positive direction
		Red	The cell current in negative direction

SALT CHLORINATOR ON/OFF/AUTO: ON/Off Switch. In Auto mode, the chlorinate is operated by the timer setting.

Light On/Off: Switch for underwater light connected to the control unit (For certain models)

System Control button: Adjust the length of time of chlorinator production.

For example: 76

Set at 100% = the salt cell operate continually.

Set at 50% = the salt cell operate for 30 minutes in each hour and is idle for 30 minutes.

Set at 30% = the salt cell operate for 18 minutes in each hour and is idle for 42 minutes.

Winter Mode Switch and On/ Off LED: Turn on to change the chlorine production to 85% of the system production setting.

Cell Polarity LED: Shows the polarity of the electrodes; the polarity of the electrode will reverse every 8 hours, in order to remove any deposit on the electrode.

Timer: (timer models only) Programs the on and off times for the unit and pump to run automatically.

Stand-By LED: Displays when the chlorinator is in stand-by mode. When the chlorinator is turned on, the stand-by LED will go off after 35 seconds.

No Flow LED: Displays when there is no water flow. If there is no water in the cell enclosure, the pump and salt chlorinator will stop automatically.

7. TIMER SETTING FOR TIMER VERSION

1. Turn the clock face until the time of the day is aligned with the clock at the center of the timer hand.
2. The 24-hour dial has 15 minutes division. The timer can be programmed by pushing the captive trippers to the outer ring position for the entire period that the load is to be turn ON.
3. The timer clock will rotate with time; the chlorinator will be turned on automatically if its captive tripper is pushed outward.



8. MAINTENANCE AND TROUBLESHOOTING

A salt chlorinator is a valuable piece of pool sanitizing equipment. Regular care and maintenance will ensure the best performance and long life. Keep the water chemical balance

1. Maintain the correct water chemical balance
2. Maintain a good operating environment
3. Regularly check the condition of the titanium plates. During the chlorination process white calcium scale may naturally build up on the titanium plates in the cell. Regular monitoring of the cell will prevent excessive buildup of scale. Excessive scale will damage the cell and significantly reduce its life and efficiency.
4. If the control box fails or there is excessive calcium deposit, maintenance must be carried out by a pool professional.
5. Prevent insects from entering the control box, they may damage the electrical components inside.

9. TROUBLE SHOOTING

	How To Handle
Salt level is too high and causing over heat.	Check the salt level is within operation range, refer to individual model recommendation. It will resume output when salt level is normal.
Check the electrical plug/control box/ pump power	Connect the power properly
System setting is too low	Turn the system control to maximum
Automatically stopped by the timer setting	Adjust the timer setting
Blown fuse	Unplug the power and replace the fuse
Excessive scale build up on the cell	Switch off the salt chlorinator and request cleaning the salt cell by professional pool service.
Water temperature too low	Turn on the winter switch
Salt lever too low	Add salt to the pool
Pump malfunction	Stop the filtration system and repair the pump
Filter Backwashing	Once the backwash is complete, turn the filter back to normal filtration
The gas sensor is not connected	Connect the gas sensor according to this manual
System setting too low	Turn the system control to maximum
Display 888	Replace the Internal fuse

10. ELECTRICAL WIRING

10.1 MAIN PCB

The main controller PCB has two connectors.

1. 13 pins flat cable connector for the power module
2. 4 pins cable connector, blue and gray color pins connect to the power switch.

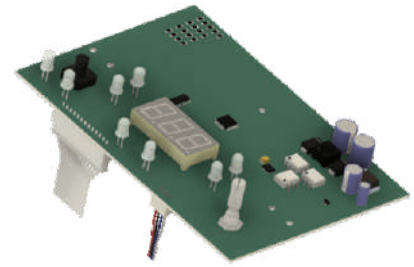

10.2 POWER MODULE

A salt chlorinator is a valuable piece of pool sanitizing equipment. Regular care and maintenance will ensure the best performance and long life. Keep the water chemical balance

1. Maintain the correct water chemical balance
2. Maintain a good operating environment
3. Regularly check the condition of the titanium plates. During the chlorination process white calcium scale may naturally build up on the titanium plates in the cell. Regular monitoring of the cell will prevent excessive buildup of scale. Excessive scale will damage the cell and significantly reduce its life and efficiency.
4. If the control box fails or there is excessive calcium deposit, maintenance must be carried out by a pool professional.
5. Prevent insects from entering the control box, they may damage the electrical components inside.

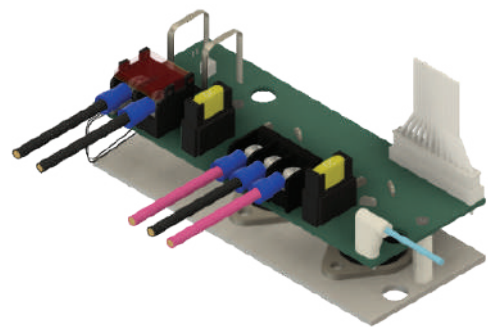

SSC15 & SSC25 no fuse
SSC50 is 30A.

10.3 TRANSFORMER

The transformer has two voltage inputs:

240Vac (blue) for Australia, New Zealand and UK.

220Vac (white) for rest of the world.

Avoid burn injuries: Do not touch the transformer before switching it off and allowing it to cool.

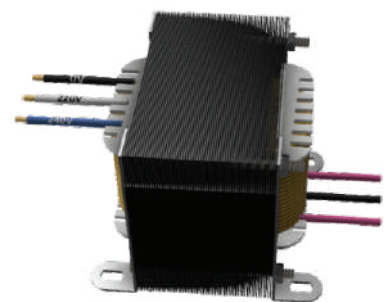

10.4 TERMINAL BLOCK

The terminal block in the middle of the chassis is used to select input AC voltage 220V or 240V, input power fuse protection and connection to transformer input.

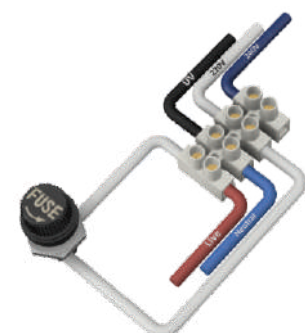

SSC15/25/50E WIRING DIAGRAM

SSC15/25/50-T WIRING DIAGRAM

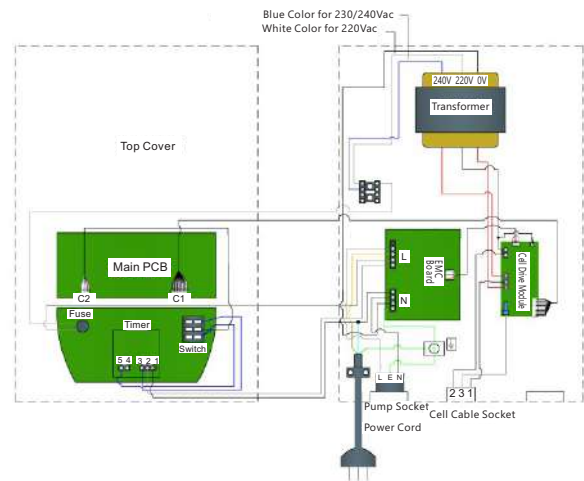
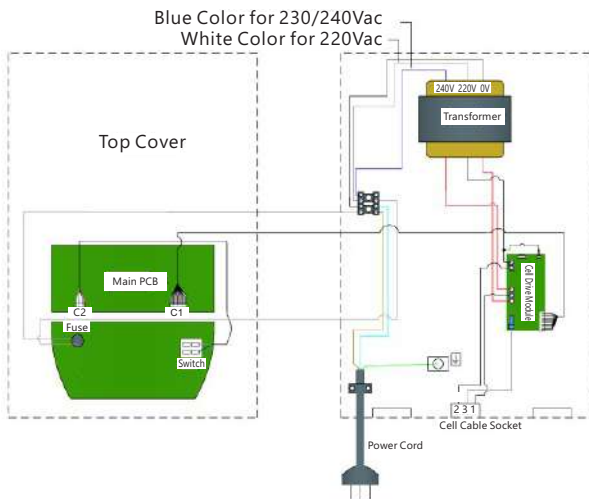

11. CLEANING THE TITANIUM CELL



Although the system is designed with a self-cleaning function for the cell (reverse polarity), it will occasionally be necessary to manually clean the cell to remove calcium deposit. enclosure, the pump and salt chlorinator will stop automatically.

Caution

At the mixture required for cleaning is extremely corrosive and protective clothing should be worn.

Procedures

Make up a dilute mixture of 1:10 parts of Hydrochloric (muriatic) Acid to water.



Always add Hydrochloric acid to water

1. Turn the filtration system off.
2. Remove the salt cell from the housing.
3. Add the salt cell to the cleaning mixture making avoiding contact with the terminals.
4. Wait five to ten minutes for the Salt Cell to be cleaned.
5. If any parts of calcium are stuck or will not dissolve, carefully remove them with a smooth plastic instrument.
6. Once the salt cell is clean, rinse with fresh water and place back in the housing and tighten the cell or collar.
7. Turn system back to automatic setting or timer. Dispose of cleaning mixture.

If the salt cell has a heavy deposit of calcium that has not been removed after ten minutes in the cleaning solution, we recommend using a "Cell Cleaner" product which is not as corrosive as hydrochloric acid. The cell can then be left in the cleaner for up to a hour and will completely remove the calcium.

We recommended using Salt Cell Cleaner at all times over the traditional Hydrochloric mixture, it is a safer alternative and not harmful to your Salt Cell at all and reusable.



12. TERMS OF THE WARRANTY

As original purchaser of this equipment have purchased from Emaux Water Technology Co Ltd, through Authorized International Distributor or Dealer, warrants its products free from defects in materials and workmanship under normal use during warranty period. The warranty period begins on the day of purchase and extends only to the original purchaser. It is not transferable to anyone who subsequently purchases the product from you. It excludes all expendable parts.

During the warranty period, Emaux authorized reseller will repair or replace defective parts with new parts or, at the option of Emaux, serviceable used parts that are equivalent or superior to new parts in performance.

This Limited Warranty extends only to products purchased from Emaux authorized reseller. This Limited Warranty does not extend to any product that has been damaged or rendered defective (a) as a result of accident, misuse or abuse;

(b) as a result of an act of God;

(c) by operation outside the usage parameters stated herein;

(d) by the use of parts not manufactured or sold by Emaux;

(e) by modification of the product;

(f) as a result of war or terrorist attack; or

(g) as a result of service by anyone other than Emaux authorized reseller or authorized agent.

EXCEPT AS EXPRESSLY SET FORTH IN THIS WARRANTY, EMAUX MAKES NO OTHER WARRANTIES EXPRESSED OR IMPLIED, INCLUDING ANY IMPLIED WARRANTIES OR MERCHANTABILITY AND FITNESS FOR A PARTICULAR PURPOSE. EMAUX EXPRESSLY DISCLAIMS ALL WARRANTIES NOT STATED IN THIS LIMITED WARRANTY. ANY IMPLIED WARRANTIES THAT MAY BE IMPOSED BY LAW ARE LIMITED TO THE TERMS OF THIS EXPRESS LIMITED WARRANTY.

Installation template

Ratio 1:1

